

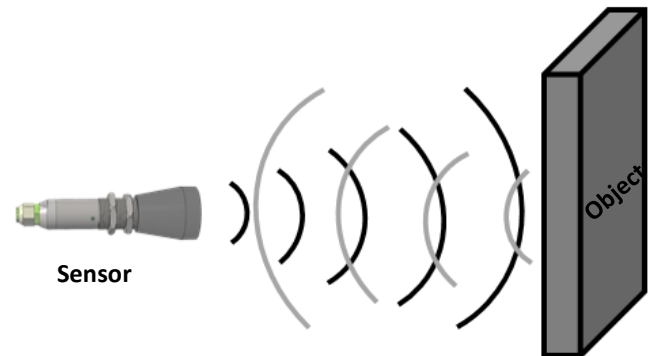

The ultrasonic sensors send and detect high-frequency ultrasonic sound with a piezoelectric transducer. A part of the reflected sound wave by hitting the measuring surface is detected by the transducer, depending on the speed of the signal in the air, the distance of the objects is determined. When the specified switching point is reached, the output is switched. The measured value is given as analog (0 ... 10 V, 0...20 mA, 4 ... 20 mA) or CANopen signal.

With ultrasonic sensors, objects can be reliably detected and measured regardless of material, color, transparency and surface properties.

ULT series ultrasonic sensors, designed and manufactured by Atek Sensors R&D engineers, are used in contactless and level measurements of liquid and solid materials in open and closed tanks. It is very easy to install with its small body structure.



GENERAL FEATURES

- Ultrasonic working principle
- Different measuring options up to 6 meters
- Acid-proof option
- Non-contact and high precision measurement
- $\pm 0.2\%$ FS accuracy
- RS-232, RS-485, CANopen serial connection options
- 4-20 mA, 0-20 mA, 0-10V analog output options
- 2 pcs switch output (PNP open collector)
- IP67 high protection class
- Small structure
- Economical and maintenance-free design
- Easy installation

APPLICATION AREAS

- Level measurement, pump control in tank, warehouse etc.
- Occupancy rate calculation in product warehouses
- Treatment plants
- Food industry
- Chemical industry

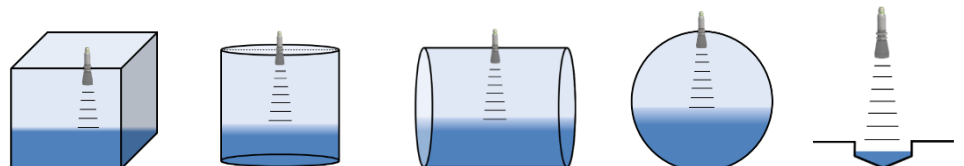

TECHNICAL SPECIFICATIONS



MODEL	ULT30-40	ULT30-75	ULT30-75A
Max working distance	6000 mm	4000 mm	2000 mm
Blind zone	400 mm	200 mm	200 mm
Frequency	40 kHz	75 kHz	75 kHz
Angle	30°	12°	12°
Acid Proof	X	✓	✓ (strong acid)
Housing material	316L, Delrin	316L, Delrin	Teflon
Accuracy	±%0.2 FS		
Supply voltage	16...30 VDC		
Power consumption	2,4 Watt max.		
Current consumption	100 mA max. @24 VDC / 150 mA max. @16 VDC		
Sampling rate	4 Hz		
Minimum resolution	1 mm		
Switch outputs (optional)	2 x PNP Open Collector		
Serial communication (optional)	RS-232, RS-485, CANopen		
Analog outputs (optional)	0-20 mA, 4-20 mA, 0-10 V, 0.5- 4.5 V, 0-5 V 20-0 mA, 20-4 mA, 10-0 V, 4.5-0.5 V, 5-0 V		
Analog output load	500 Ω		
Analog output resolution	16 Bit (better than 1 mm)		
Reverse connection protection	Yes		
Temperature compensation	Yes		
Watchdog	Yes		
Electrical connection	M12 / 8 pin male or M12 / 5 pin female connectors (standard) 8 x 0,14 mm ² shielded cable or 5 x 0,14 mm ² shielded cable (optional)		
Cable length	Standard 1m, Optional other lengths		
Operating temperature	-40 °C ... 75 °C		
Storage temperature	-40 °C ... 85 °C		
Protection class	IP67		
Weight	~400 gr		

RS-232 / RS-485 SPECIFICATIONS

Communication Protocols	ASCII, Modbus RTU, Modbus ASCII Default: Modbus RTU
Baud Rate	600, 1200, 2400, 4800, 9600, 14400, 19200, 38400, 57600, 115200 Default: 9600
Parity	None, Odd, Even Default: None
Address	Between 1 and 247 Default: 1

CANopen SPECIFICATIONS

Communication Profile	CiA 301
Response Frequency	100 Hz.
Device Type	CANopen, CiA 301
Node ID	Between 1 and 127, configurable via LSS or SDO.
Baud Rate	10 kBit/s, 20 kBit/s, 50 kBit/s, 100 kBit/s, 125 kBit/s, 250 kBit/s, 500 kBit/s, 800 kBit/s, 1 Mbit/s
PDO Data Rate	100 ms
Error Check	Heartbeat, Emergency Message
PDO	1 Tx PDO
PDO Modes	Event/Time triggered, Synch/Asynch
SDO	1 server
Position data	Object Dictionary 6004
Terminating Resistor	Optional

MECHANICAL DIMENSIONS (in mm)

ULT30-40

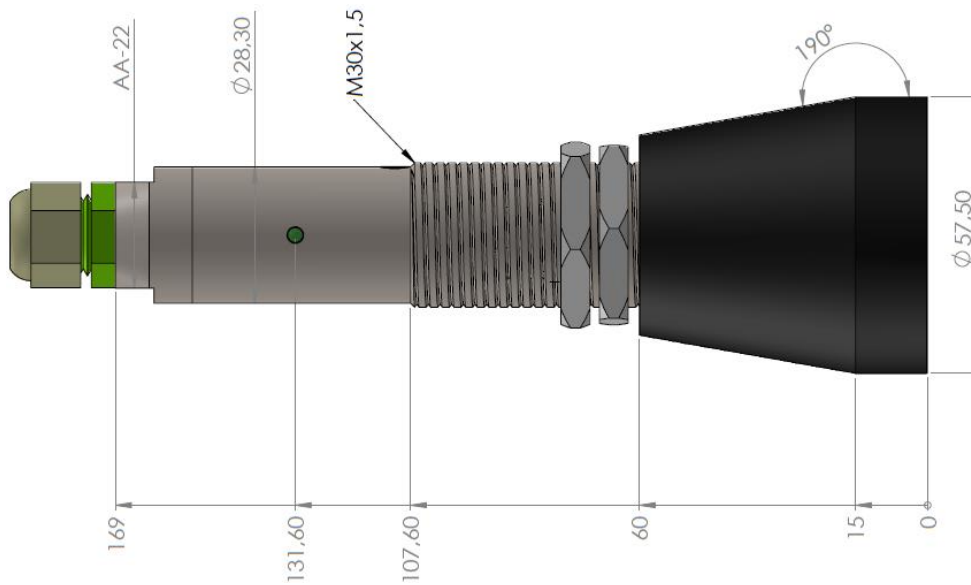

ULT30-75 / ULT30-75A

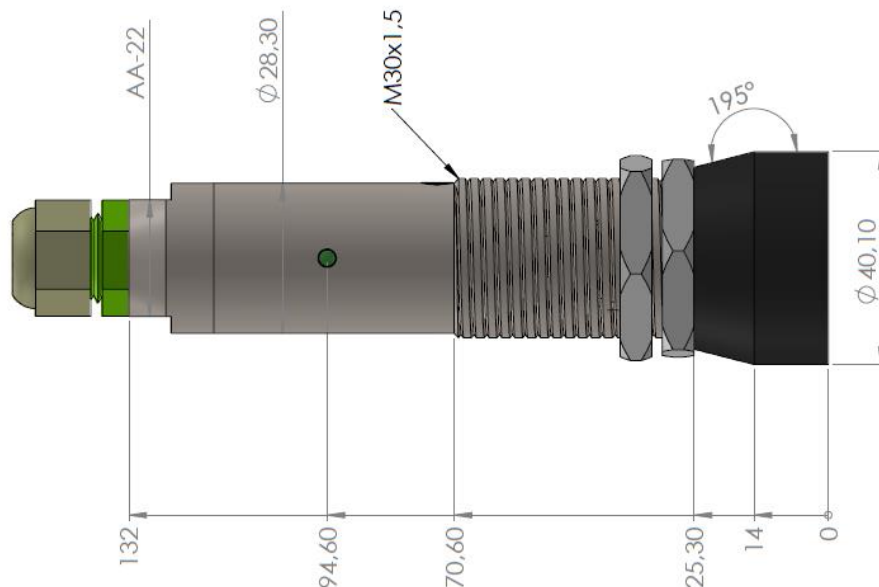

ELECTRICAL CONNECTIONS

CN1 (M12 / 8 Pin connector or 8x0,14 mm² cable)

Pin No	Signal	Cable Color
1	16..30VDC Supply input	Red
2	GND – 0V	Black
3	Analog Out -	Green
4	Serial Communication (RS232 - Tx) (RS485 - B) (CAN - L)	Blue
5	Serial Communication (RS232 - Rx) (RS485 - A) (CAN - H)	White
6	Analog Out +	Yellow
7	Open Collector Output 1	Grey
8	Open Collector Output 2	Pink

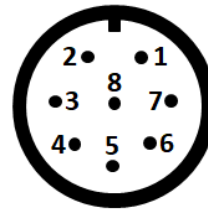

M12/8 Pin male connector
(front view of the connector on the sensor)

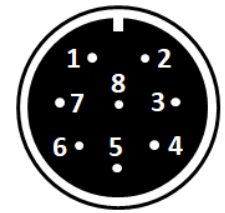

M12/8 Pin female connector
(front view of the cable-mounted connector)

CN2 (M12 / 5 Pin connector or 5x0,14 mm² cable)

Pin No	Signal	Cable Color
1	16..30VDC Supply input	Red
2	GND – 0V	Black
3	Analog Out +	Yellow
4	Analog Out -	Green
5	N/C	Pink

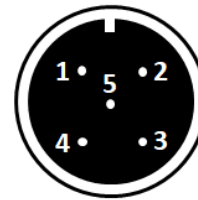

M12/5 Pin female connector
(front view of the connector on the sensor)

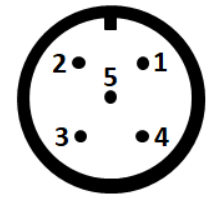

M12/5 Pin male connector
(front view of the cable-mounted connector)

MOUNTING

Measuring Distance and Angle

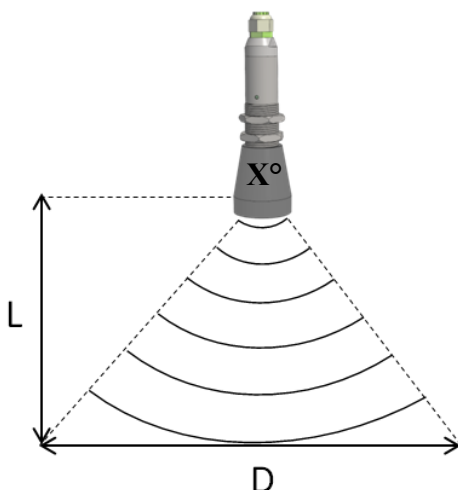

L	ULT30-40		ULT30-75, ULT30-75A	
	30°		12°	
	OPTIMUM	MINIMUM	OPTIMUM	MINIMUM
	D			
1m	60 cm	60 cm	20 cm	15 cm
2m	110 cm	80 cm	35 cm	25 cm
3m	160 cm	110 cm	55 cm	50 cm
4m	220 cm	130 cm	70 cm	60 cm
5m	270 cm	140 cm	-	-
6m	330 cm	150 cm	-	-

L indicates the mounting height and there should be no obstacle which blocks signals in D width. These values are optimally included in the table above. If optimum dimensions are not followed, level measurement is made, but measurement accuracy decreases.

If it is not possible to install in optimum dimensions, the minimum dimensions must be followed.

Mounting Warnings

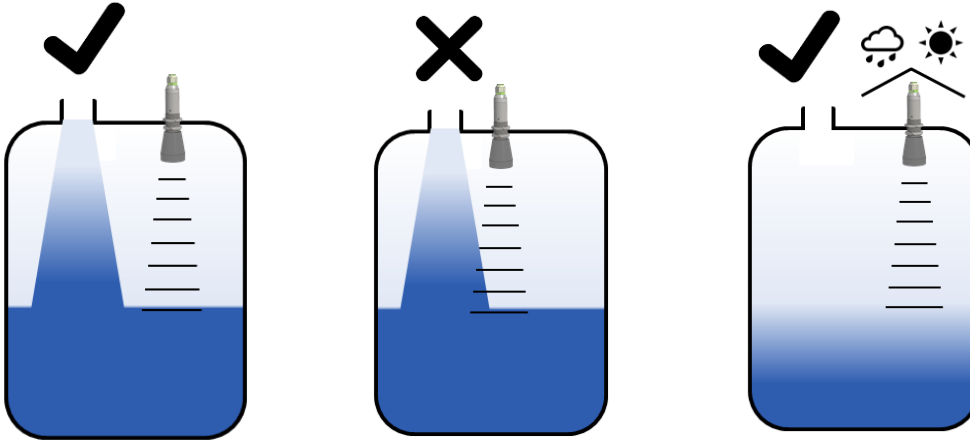

- For level measurement, the sensor must not be installed near the tank input.
- It is recommended that the sensor be protected against sun and rain.

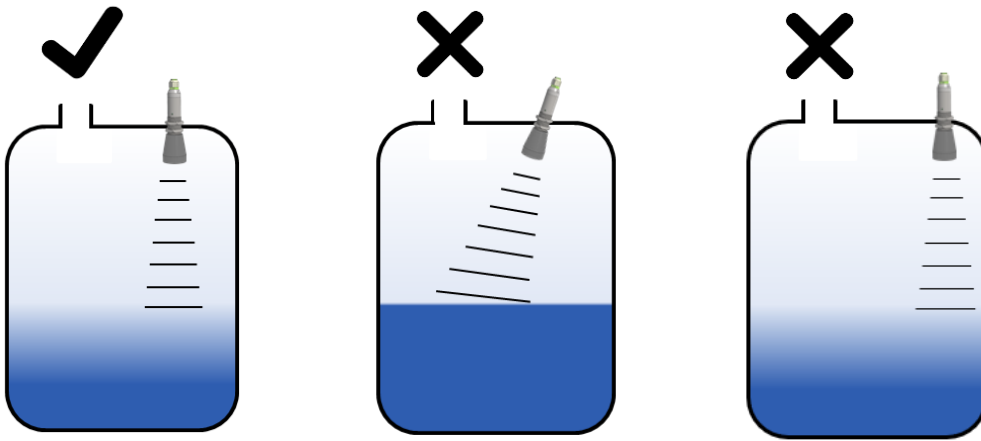

- The sensor must be installed perpendicular to the surface to be measured and should not be placed close to the side surface.

ANALOG OUTPUT AND SWITCH CONFIGURATION WITH MAGNET

Device has 4 settings values.

- 1-Analog minimum point: After which value will it start to analog value.
- 2-Analog maximum point: The final point that analog output will value.
- 3-Switch Out1 Set point menu: Output will high at this set point.
- 4-Switch Out1 Set point menu: Output will high at this set point.

If the magnet is touched for less than 5 seconds, the current position of the device is the set point.

If the magnet is touched for more than 5 seconds, and less than 15 seconds, device passes to the next menu.

If the magnet is touched for more than 20 seconds in first and second menu, device loads factory default if it is in first menu, device inverse analog output if it is in the second menu.

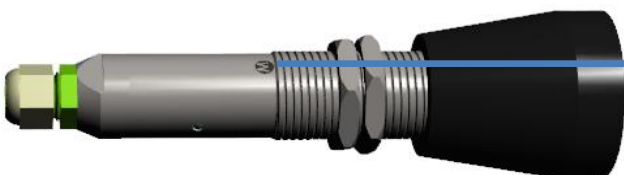

The zone where the adjustment magnet is approached

CONFIGURATION FLOWCHART

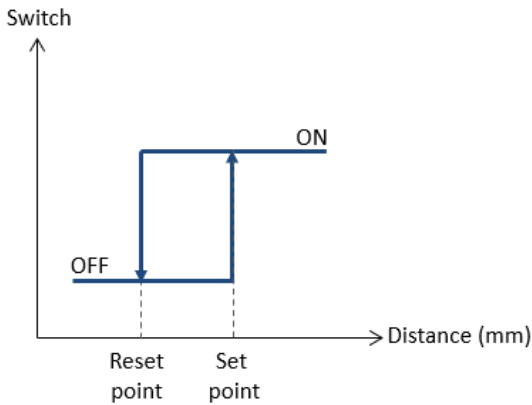
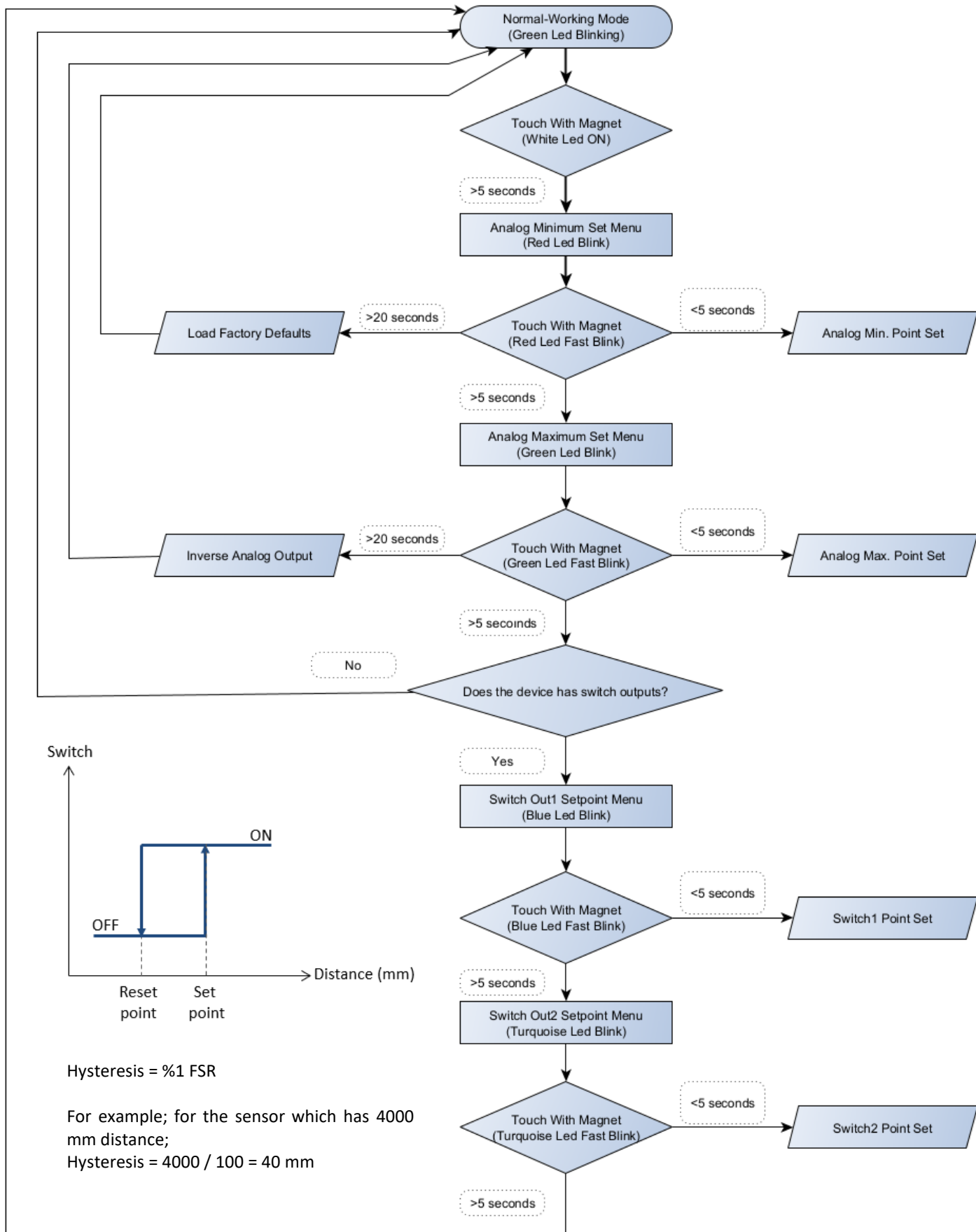

Hysteresis = %1 FSR





For example; for the sensor which has 4000 mm distance;
 Hysteresis = 4000 / 100 = 40 mm

ORDER CODE

Model	Max. Measuring Range	Digital Output	Electrical Connection ⁽²⁾
ULT30-40 ULT30-75 ULT30-75A	2000 mm (ULT30-75A) 6000 mm (ULT30-40) 4000 mm (ULT30-75) Can be selected up to distances above.	No code: No digital output C: CANopen S1: RS-232 S2: RS-485	S14M: M12/8 pin male S13F: M12/5 pin female 1M: 1 meter cable (*optional other lengths)
ULT30-XXX	XXXX	XX	XX
Housing Material⁽¹⁾ M: 316L stainless steel D: Delrin (acid-proof) T: Teflon (strong acid-proof, only for ULT30-75A)	Analog Output No code: No analog output V0 : 0-10 VDC V1 : 0-5 VDC V3 : 0.5-4.5 VDC A0 : 0-20 mA A4 : 4-20 mA NV0 : 10-0 VDC NV1 : 5-0 VDC NV3 : 4.5-0.5 VDC NA0 : 20-0 mA NA4 : 20-4 mA	Switch Output No code: No switch output OCP: 2 x PNP open collector	

- (1) Housing Material:
 ULT30-40:316L, ULT30-75:316L or Delrin, ULT30-75A:Teflon can be selected.
- (2) The product can be requested with cable or connector. In models with socket; S13F code socket should be selected only when product with analog output is desired. If different outputs are desired in addition to analog output, S14M code socket should be selected. ULT30-75A product is only produced with cable in terms of acid resistance. Only analog output can be selected in the ULT30-75A.

OPTIONAL PRODUCTS

Product	Code	Description
	S14F	M12/8 pin female connector (IP67) (For connection with M12/8 pin male connector on the sensor)
	S13M	M12/5 pin male connector (IP67) (For connection with M12/5 pin female connector on the sensor)
	CB8 XM / S14F	X meters 8x0,14 mm ² extension cable + M12/8 pin female connector (IP67) X = Max. 50 meters
	CB5 XM / S13M	X meters 5x0,14 mm ² extension cable + M12/5 pin male connector (IP67) X = Max. 50 meters

Atek Elektronik Sensör Teknolojileri Sanayi ve Ticaret A.Ş.



Gebze OSB, 800. Sokak, No:814 Gebze/KOCAELİ/TURKEY



Tel: +90 262 673 76 00



Fax: +90 262 673 76 08



www.ateksensor.com



info@ateksensor.com